

Sanitary rooms for office and commercial buildings

schäfer[®]
Trennwandsysteme



Stylish and elegant partitioning.

Toilet partition walls and privacy screens	4-29
Cloakroom and staff lockers	30-32
Shower partitions	33-34
Accessories	35
Variations of accessories	36



BEFORE WE
EXPECT TRUST FROM
OUR CUSTOMERS,
WE PROVIDE EVIDENCE
that's us!

ENVIRONMENT & SUSTAINABILITY

that's us!

Sustainable management and careful use of resources are a matter of course for us and part of our corporate philosophy. This basic idea is consistently integrated and lived in our work processes.

We are proud to be the first certified manufacturer of partition systems and lockers in Germany to operate according to the FSC™ and PEFC guidelines.

PEFC - registered

We pay attention to a sustainable supply chain in which our products are procured under ecological, economic and socially just aspects.

FSC™ - certified

As the first certified manufacturer in the area of partition systems and lockers in Germany, we make an active contribution to the protection of our earth with this future-oriented procurement method. We supply almost our entire range from sustainable wood in accordance with the specifications of the FSC™.



On request
the products are
available with
FSC™ certification

MADE IN GERMANY

that's us!

Our products are manufactured for you at the company site in Horhausen, Rhineland-Palatinate. This is the only way we can guarantee the high quality standards we set for our products.



PREQUALIFIED

that's us!

We are registered in the list of prequalified construction companies with the number 010.049740, proving that we are qualified for the products and services we offer.



INNOVATIVE & DESIGN-ORIENTED

that's us!

With our design-oriented and innovative products, we convince not only our customers, but also national and international committees.



Toilet partition walls and privacy screens





Contact-free opening and closing.



Contact-free into the toilet partition. Ensure permanent hygiene in the sanitary room.

- Look&Wave is the first contact-free toilet partition. That means you can open and close the cubicle door without touching it, thanks to modern LED and sensor technology
- Look&Wave is an innovative concept that considerably reduces the transmission of germs
- Look&Wave closes the hygiene gap in sanitary facilities and enables the realisation of completely contactless toilet rooms
- Look&Wave makes the sanitary room concept to a contemporary and fresh hygiene experience for visitors and employees
- Look&Wave leaves the user with a lasting positive impression and a good sense of hygiene

[More about the product variety Look&Wave >](#)



Contact-free opening and closing.

Optimal visitor guidance. Intuitive operation

- Large LED displays with sensor area make it easier to find a free cubicle even when entering the room
- Intuitive operation of the sensor
- Optimal visitor guidance especially in highly frequented facilities

Opening the door

- Easily hold your hand in front of the marked sensor area and the door opens

Locking the door

- No contact is required for locking either
- Easily hold your hand in front of the sensor area in the cubicle and the door closes and locks
- As soon as the lock is activated, the LED indicators inside and outside switch to red
- This gives security to the user and signals the occupied status in the outside area

Unlocking the door

- By holding your hand in front of the sensor area, the lock unlocks and automatically the door opens

The Look&Wave technology

- With the Look&Wave technology, contactless operation of the toilet cubicle is possible
- The Look&Wave technology offers an integral hygiene concept in the sanitary area in combination with other sensor systems for e.g. WC flush, water tap or soap dispenser
- The Look&Wave technology gives the user a pleasant clean feeling
- **Germ and bacteria transmission is reduced to a minimum by the Look&Wave technology and hygiene is permanently ensured**

[More about the product variety Look&Wave >](#)



Touch-free operation, thanks to modern sensor technology.
Ensure permanent hygiene.

[More about the product variety Look&Wave >](#)





Toilet partitions
made of glass.
Advantages in the
sanitary area:

- Material properties ensure very high quality
- Especially hygienic
- Easy to clean
- Robust and durable
- High resistance to mechanical damage
- Elegant design
- A perfect impression even after many years of use
- The glass material ensures careful handling and thus prevents vandalism



PREMIUMLINE
Exclusive as your requirements

(1)



(2)



(3)



(4)

The VENTO glass cubicle sets new standards.

For both glass toilet partitions and floor-to-ceiling constructions. A highly exclusive and unique system.

(1)

Clean and pure look. Elegant. Perfectly formed

- Continuous glass elements, without visible fittings
- Various high-quality door handle variants are available
- Glass available in almost all RAL colours
- The option to choose individual prints and patterns

(2)

Strong construction

- Door made of a 50 mm thick, torsion-resistant sandwich construction
- Including 5 mm thick ESG-H panel on both sides
- Aluminium inner frame
- Doors up to 3000 mm high

(3)

Door function of the VENTO system

- The door is guided through a floor and ceiling bearing
- Convenient self-closing function
- Soft-close function enables silent closing

(4)

Door handles

- High-quality door handles with discreet vacant/occupied indicators on the outside of the cubicle. This image shows the door handle in chrome finish



 **PREMIUMLINE**
Exclusive as your requirements

(1)



(2)



(3)



(4)

Toilet partitions made of glass type VENTO

(1) + (2)

Toilet partition

- Wall and ceiling connections as a subtle shadow gap
- The construction hides connections
- Tolerances can be compensated

(3)

Door handle

- Door handle made of stainless steel
- Large vacant/occupied display on the outside of the cubicle
- Door handle with rosette for locking on the inside of the cubicle, also made of stainless steel

(4)

Door construction

- Completely internal aluminium frame
- This means that only glass is visible on the surface
- Door fittings can be aluminium, chrome-plated or stainless steel, as shown here
- Clean and elegant look

Toilet partition walls and privacy screens



Toilet partitions made of glass type VITRUM III

(1)

Elegant partition solution for exclusive requirements

- Made of safety glass (ESG-H)
- Optionally also available in laminated safety glass (VSG)
- Flush-fitting front
- Minimalist fitting solutions made of stainless steel
- Washbasin cover also made of glass for the perfect sanitary room design

(2)

Wall-mounted urinal screens made of safety glass

- Perfectly matched to the design of the toilet partitions
- Fastened with stainless steel brackets
- Particularly hygienic and easy to clean due to the construction and material properties

(3)

Individual colour design

- Colour selection is based on the RAL colour chart
- Almost limitless design options
- Colour combinations and motif prints also available

(4)

Elegant special solution with VITRUM III

- Special solution without covers between the individual doors

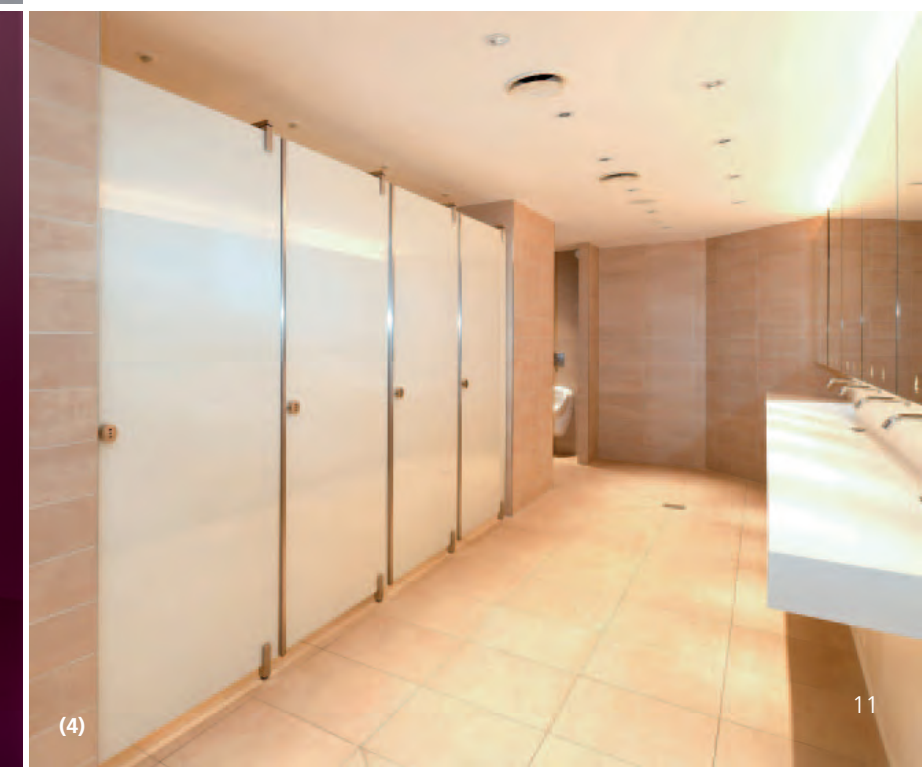



Toilet partitions made glass type VITRUM II

(1)

Individual motif prints

- For the design of perfectly coordinated room concepts
- Customer-specific motif prints enable unique partition wall designs
- The motif is already printed on the carrier plate during glass production. This gives the glass the same high surface quality as conventional screen printing
- Themed concepts can thus also be perfectly realised in the sanitary area

(2)

Toilet partition with a floating look

- Construction with recessed feet and recessed head rail
- Elegant and stable aluminium fittings
- Easy-to-grip aluminium door knob
- Smooth surfaces make cleaning easier
- Particularly hygienic due to the material properties

(3)

Exclusive, durable and easy to clean

- Cubicle system made of safety glass (ESG-H)

(4)

Toilet partition as corner variant

- Made of safety glass (ESG-H)
- Glass urinal screens as a wall-mounted construction
- Particularly easy to clean



Privacy screens made of glass

- Wall hanging construction
- Made of enamelled safety glass (ESG-H)
- Mounting by means of discreet aluminium brackets
- Hygienic and easy to clean
- Waterproof
- Easy floor cleaning due to the construction
- Colour selection according to RAL colour chart
- Motif prints optionally possible
- Privacy screens will be produced acc. to the building site dimension



Room-high systems in the sanitary area. Advantages:

- More privacy due to the closed-off area
- Well-being of the users is increased
- Optimal use of the available space, as elements are significantly narrower than classic drywall
- The option to select individual colours and motifs, making the system a design element
- Easy cleaning thanks to smooth elements with internal wall and floor connections
- Faster and cheaper than conventional drywall



TOI TOI Superior Line Sanitärcontainer.
Foto: ADCO GmbH

(1)

Room-high toilet partitions, type EF-3 ALTUS

(1)

Premium product EF-3 ALTUS

- Smooth, flush-fitting front
- Continuous elements
- Completely water resistant
- Invisible fitting solutions
- The front shown here is also curved.
Just one of many options

(2)

Absolutely individual and hygienic

- Motif prints are tailor-made according to customer requirements
- Wall-mounted partitions made from coloured enamelled safety glass
- Particularly easy to clean thanks to the construction

(3)

Design options

- Panel decors and door handles are realized entirely according to customer requirements
- WC partitions here shown with elegant handrail and energy-saving LED display next to the handle



(2)



(3)



(1)

Room-high toilet partition EF-3 ALTUS with LED display

- Clearly visible, LED free/occupied display
- Signals the free/occupied state from a distance
- Minimalist stainless-steel one-hand door knob as an option
- Motifs and patterns can be created to the customer requirements

(2)

Floor-to-ceiling corner system

- Concealed floor, ceiling and wall connections
- Individual printing
- Motif is printed during the manufacture of the HPL panels
- Protective overlay makes the surface hard-wearing
- Easy to clean and robust surface



Room-high toilet partitions, type SVFG40

(1)

Room-high toilet partition with wooden decor

- For particularly elegant and high-quality sanitary rooms
- Ideal solution for dry areas
- A wide range of wood grains are available
- Construction from 40 mm-thick chipboard panels
- Toilet partitions and wash basin in the same design

(2)

Optional for SVFG40 cubicles

- Hinges that are completely hidden in the rebate
- Flush fitting on the inside and outside of the cubicle
- Also available with self-closing function
- Door edges milled from high-quality, real wood edge material
- Various types of wooden colours and uni colours available

(3)

Optional special frame construction for the doors

- Allows continuous doors without top panel
- Frame construction guarantees low weight with high stability
- Perfectly coordinated with the WC partition walls the washbasin solution completes the sanitary room concept

(4)

Hardware solutions

- We have a wide range of hardware solutions to choose from
- Can be adapted to structural conditions (e.g. existing access doors)



(1)



(2)



(3)



(4)

(1)

Room-high toilet partition type SVFG40 ALTUS

- Front elements without joints from floor to ceiling
- Top panel fits flush above the doors
- Upper panel mounted without visible fasteners

(2) + (3)

Tailored customer motif

- Image is pressed into the laminate during the production of the panel
- Extremely scratch-resistant and robust surface

(4)

Privacy screens made of glass

- Wall hanging construction
- Made of enamelled safety glass (ESG-H)
- Mounting by means of discreet stainless steel or aluminium brackets
- Hygienic and easy to clean
- Waterproof
- Easy floor cleaning due to the construction
- Colour selection according to RAL colour chart
- Motif prints optionally possible
- Privacy screens will be produced acc. to the building site dimension



Room-high toilet partitions type SVF30/S ALTUS

(1)

- Doors with flush-mounted top panel
- Wood decor provides a noble contrast and an exclusive room ambience
- Particularly easy to clean thanks to the smooth surface and the material properties

(2)

- Variant without top panel
- Can be constructed in one piece up to a height of 2250 mm
- Fronts flush-fitting without visible fittings
- Easy cleaning and maintenance
- Doors with self-closing hinges optional
- Doors with self-opening hinges optional
- More space-saving than conventional drywall
- Visually very appealing
- Easy to clean
- Large variety of colors and decors

(3)

- Matching privacy screens type SVF30
- Wall-mounted construction
- Made of 30 mm thick chipboard
- ABS strips and panels in the same colour
- Fastening by means of wall brackets made of anodized aluminum
- Floor clearance ensures an effective cleaning
- Easy to clean surface
- Wide range of colours available
- Motif prints are optionally available
- Privacy screens will be produced acc. to the building site dimension





(1)



(2)

Room-high toilet partitions, type SVF30/S ALTUS

The SVF30/S ALTUS toilet partition is the ideal entry-level solution for closed toilet partitions. This type of system consists of 30 mm thick chipboard panels and is ideally suited for the design of dry room areas.

(1)

Toilet partition

- Quality chipboard with 0.8 mm laminate on both sides
- Stable and durable construction
- ABS edging in the same colour as the panels
- Wall-mounted privacy screens made of safety glass

(2)

Top panel flush-fitting above the doors

- Invisible fastening using compression spring pins
- Stainless steel hinges with treads made of high-performance polymer
- Hinges embedded flush in the edge
- Self-closing function optional



Toilet partitions with floating optic. Advantages:

- Exceptional and exclusive construction
- Particularly attractive design
- A highlight in the sanitary room
- Easy floor cleaning
- Faster and more efficient cleaning and maintenance



Toilet partitions with floating optic type EF-3 JUMP

- Construction with recessed feet and recessed head profile
- In systems with large cubicle widths, the front parts are stabilised by a support leg





(1)



(2)



(3)



(4)

(5)

Toilet partitions with floating optic type SVF30 JUMP

(1)

Sanitary partition wall

- Recessed feet and head rail mean the system appears to floating
- Particularly easy to clean
- Made of 30 mm chipboard panels
- Excellent for the design of dry rooms
- The wall connections are made by shadow gaps (not possible with cut outs)
- Smooth and easy-care fronts

(2)

Privacy screens

- Made of 13 mm HPL material
- Intense colours create a successful contrast
- Wall-hanging construction using stable wall brackets made of anodised aluminium
- Particularly easy to clean and hygienic
- Printed motif walls are another visual highlight and a central design element
- The choice of motif is left entirely to the customer

(3)

Wash stands

- Made of 13 mm waterproof HPL material
- A similar colour and material concept creates harmony

(4) + (5)

Sturdy construction

- Stable aluminium bracket
- Stable head rail, recessed by 150 mm
- The fittings are not visible in the front and make the system appear suspended and light
- Stainless steel or aluminium feet recessed under the centre partition
- Additional stabilising with aluminium bracket prevents breaking
- Connection between partition walls and front wall is done under the elements using a T-connector



(1)



(2)



(3)

Toilet partitions with floating optic type SVF30 JUMP

(1) + (2)

Sanitary partition wall

- Elegant solution also for row systems
- Flush-fitting fronts provide a consistently smooth surface
- Visually very appealing and easy to clean
- Colours are selected according to customer requirements
- Colour combinations can also be selected

(3)

Head rail construction

- Head rail provides the necessary stability
- Recessed by 150 mm
- Not visible in the front



Everyday office experience. Toilet partitions with motif print.

Gloomy and colourless is out. Employees and customers also want to feel good during working hours. Of course, this also includes the time when using sanitary facilities.

The choice of colours and the design of sanitary rooms plays an important role. Colours have an impact on our wellbeing. A pleasant atmosphere should therefore also be created in the toilets.

Dive into another world for a brief moment and leave the stress and hectic of everyday behind. This is also possible in sanitary rooms. Combinations of colours and motifs show an unique area. Toilet rooms with Schäfer partition systems can be really individual, colourful, unusual and grand.



(1)



(2)



(3)



(4)

**Toilet partitions and wall cladding
with motif printing type EF-3**

(1)

Sanitary partition wall

- Suitable for wet and dry rooms
- Excellent design, very stable, completely water resistant
- Flush-fitting fronts make maintenance easier
- Made from 36 mm thick sandwich elements with 3 mm thick HPL panel on both sides
- Inner torsion-resistant aluminium frame
- The door rebate is formed by the inner frame
- Noiseless door closing provided by damping rubber offers a big advantage in everyday office life
- Finger protection for even greater safety

(2) + (3) + (4)

Wall cladding

- Uniform design concept creates spaces for well-being
- Back walls and toilet partitions in the same design, implemented for all areas of the sanitary room
- Very easy to clean
- Individual choice of motif
- Almost uncountable colour combinations
- The appearance of toilet partitions with motif prints reduces damage caused by vandalism



Standard sanitary partition wall type SVFG40

- WC partition walls made of 40 mm chipboard panels with 0.9 mm HPL surface
- Completely flush front
- Easy to clean and maintain construction
- Edges made of varnished real wood
- Suitable for drying rooms
- Large variety of decors and colours



Standard toilet partitions

(1) + (2)

Cubicle system type SVF30

- Made of solid chipboard coated with melamine resin
- With coloured ABS edging
- The alternative if design is required in addition to pure functionality
- Flush system with smooth fronts, even with doors opening outwards
- This is made possible by a special stop profile
- Fast wall cleaning
- Effective edge protection
- High-quality and attractive appearance

(3)

Cubicle system type SV30

- Made of melamine-faced chipboard
- The right choice if a stable and easy-care system type is required in a basic version
- The ideal toilet partition system for sanitary areas that are kept dry
- The use of colours creates a new room concept time and again





Standard toilet partitions, type VK13

(1)

Sanitary partition wall

- Also ideal for use in highly frequented areas
- Extremely sturdy
- Very stable
- Completely water resistant
- Easy to clean
- Attractive design

(2)

Everything perfectly under control with INSAFE

- Large red and white viewing window on the inside and outside of the cubicle offers the user a secure feeling of the door being locked and makes it easier to find a free cubicle
- Particularly handy handle
- Made of sturdy as well as easy-care aluminium

(3) + (4)

All-round talent VK13

- Great scope for design in terms of material and colour
- Individual room concepts can be created
- Particularly robust and durable
- Retains an attractive appearance even after many years of use
- Colour and size of the back panels can be individually designed

In order to be able to respond in the best possible way to the needs of people with restrictions, the width of the doors is comfortable and they are equipped with an easy-grip handle.



(1)



(2)



(3)

- Handrail for toilet partition, types EF-3 / SVFG40 / SVF30**
- Matt, natural anodised
 - Very easy to clean
 - Integrated Free/engaged indicator (4)
 - Emergency opening located below – allows the locked door to be opened from the outside (5)
 - Optional available with LED
 - Optional energy-saving LED strip shows the locking status clearly visible
 - Very good grip because of the body-friendly shape

Possible Variation:

- (1)**
- Handrail adapted to the door length, always until the top edge of the door
 - Optional available: in combination with a LED strip
- (2)**
- Handrail 55 x 1.150 mm
 - Optional available: in combination with a LED strip
- (3)**
- Handrail 55 x 500 mm
 - Optional available: in combination with a LED strip

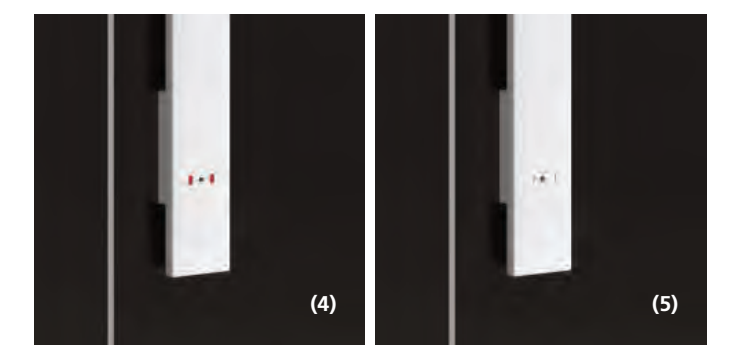

(4)

(5)

Cloakroom and staff lockers



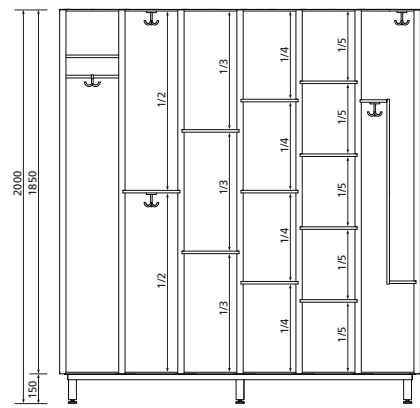

Lockers

- Many different types of locker dividers
- Single or double locker
- Multiple locker
- Z lockers
- Helmet and safe deposit boxes
- Sizes and arrangements are individually adapted to the premises

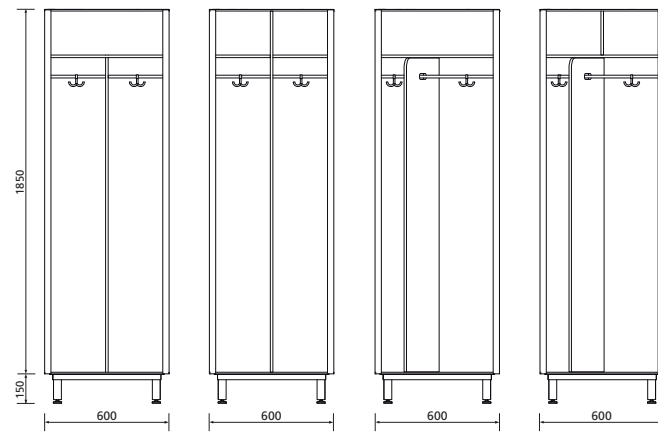

Staff cabinets as black and white lockers

- Available in different versions
- Centre partition in the locker separates street and work clothes, for example
- Centre partition also possible as a movable version

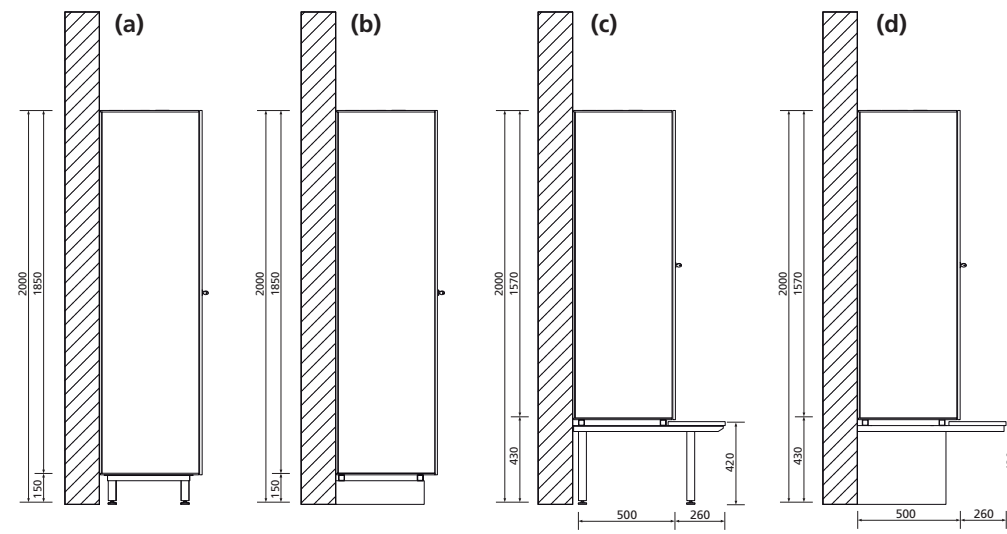

Installation options

The installation options also depend entirely on the structural situations:

- (a) Installation on an aluminum subframe
- (b) Installation on a concrete base tiled on site
- (c) Installation on an aluminium subframe with an integrated pre-built bench
- (d) Installation on a concrete base tiled on site with an integrated pre-built bench

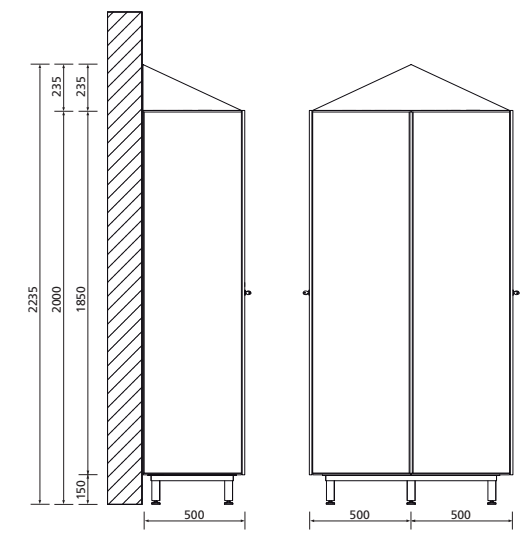

Different types of locker tops

Sloping tops prevent bags or other objects from being placed on top of the lockers. An important criterion, especially in a hygiene area.

Equipment and Accessories

(1) Very stable door stop made of stainless steel for type GVKF13 lockers

- Installed in single, double and Z lockers
- Limited 95° opening angle to
- Damping reduces noise
- Doors are equipped with concealed, maintenance-free stainless steel hinges



(2) Opening limiter for lockers of type SGVK13/AGVK13

- Noise dampened
- Guide passes through the body



(3) Interior fittings for a simple locker type GVKF13

- Hat shelf
- Clothes rail
- Sliding double hooks
- Other interior fittings on customer request

(4) Interior fittings of a simple locker type SGVK13/AGVK13

- Hat shelf
- Clothes rail
- Two sliding hooks
- Optional perforation of the locker according to customer requirements

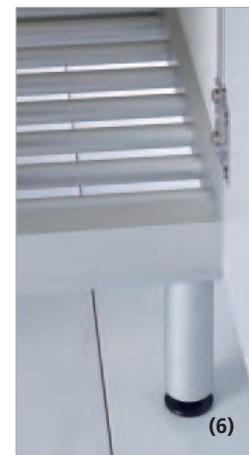
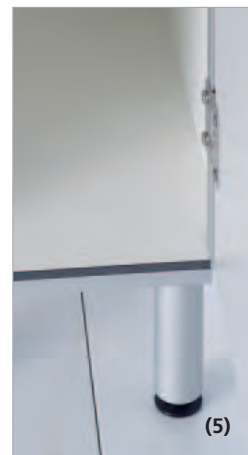

(5) Shelf, wardrobe lockers type GVKF13

- Completely closed
- Practical solid core material
- Rounded body corners
- Sturdy and easy to clean

(6) Optional locker bottom made of aluminium tubes

- Perforation or slitting of the locker bottom as an option

(8) Locking solutions

- E.g. coin locks
- Additional protection against door theft
- Anti-theft bolts for single, double and Z lockers



(9) Cylinder lever locks

as the main locking system for staff lockers

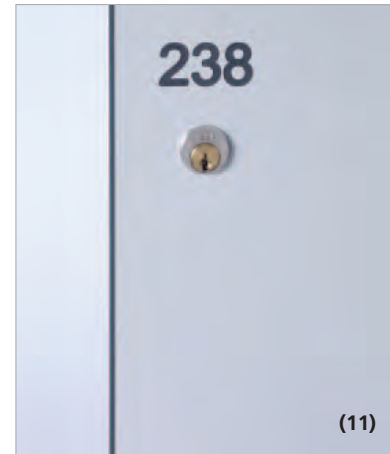
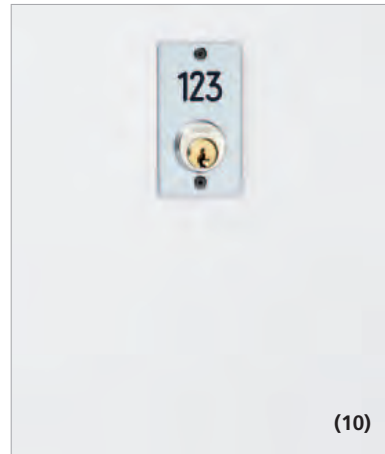

(10) Standard numbering for all locker types

- Silver-coloured plastic number plates with black engraving
- Optionally available in aluminium or stainless steel

(11) Engraving completely milled

(12) + (13) + (14) Key bracelets

- Made of different materials
- Key plates and other locker accessories can be designed individually according to customer requirements

(15) Hangers

- Made of break-proof nylon
- Matched to the standard sizes of the wardrobes

(16) Additional clothing net increases the comfort for visitors

- Additional clothing net increases the comfort for visitors

(17) Coat hanger with additional shoe hook

- Coat hanger with additional shoe hook

(18) Hanger with shoe hook and net

- Hanger with shoe hook and net

Shower partitions



More privacy
in the shower area
with shower partitions
by Schäfer
Trennwandsysteme.



(1)

VITRUM. The elegant glass variant

- Made of high quality and sturdy safety glass (ESG-H)
- Absolutely waterproof construction
- Particularly easy to clean
- Shape, colour and size can be made according to customer requirements

(2)

Shower partition wall type EF-3

- More privacy in the shower area
- Ideal splash protection
- Large variety of decors and colours

(3)

Shower cubicle Typ VK13

- Single shower cubicle with integrated changing area for dry storage of clothing
- Maximum privacy while showering and changing
- Made of high quality 13 mm thick HPL solid grade panels
- Effective and durable finger pinch protection optionally available
- High-quality anodised aluminium hardware system
- Very robust and waterproof construction
- Wide range of decors and colours



Aluminium

- Toilet roll Schäfer AL7001
- Spare roll holder Schäfer AL7002
- Toilet brush unit Schäfer AL7003
- Hook Schäfer AL7011
- Hook Schäfer AL7010
- Hook with buffer Schäfer AL7007
- Buffer Schäfer AL7015



Stainless steel

- Toilet roll Schäfer ES6001
- Spare roll holder Schäfer ES6002
- Toilet brush unit Schäfer ES6003
- Hook Schäfer ES6011
- Hook Schäfer ES6010
- Hook with buffer Schäfer ES6007
- Buffer Schäfer ES6015



Nylon

- Toilet roll Schäfer N8001
- Spare roll holder Schäfer N8002
- Toilet brush unit Schäfer N8003
- Hook Schäfer N8010
- Hook with buffer Schäfer N8007
- Buffer Schäfer N8015



Indicator stainless steel

- Male Schäfer PI1001
- Female Schäfer PI1002
- Handicapped Schäfer PI1003



We reserve the right to make technical alterations.

Variations of accessories

Hardware Type VENTO



Aluminium
door handle
Schäfer AL7050



Stainless steel
door handle
Schäfer ES6050



Stainless steel
one-hand door knob
cubicle outside

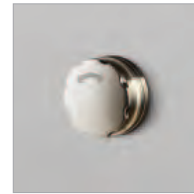

Stainless steel
one-hand door knob
cubicle inside

Hardware Type VITRUM II



Aluminium
one-hand door knob
cubicle outside



Aluminium
one-hand door knob
cubicle inside

Hardware Type VITRUM III

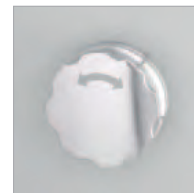

Stainless steel
one-hand door knob
cubicle outside



Stainless steel
one-hand door knob
cubicle inside

Hardware Type EF-3



Aluminium
door handle
Schäfer AL7050



Stainless steel
door handle
Schäfer ES6050



Nylon
door handle

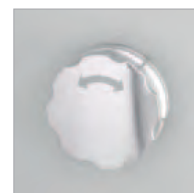

Stainless steel
one hand
door knob



Aluminium
one hand
door knob
INSAFE



Aluminium
push handle
SLIDESAFE

Hardware Type SVFG40 / SVF30



Aluminium
door handle
Schäfer AL7050



Stainless steel
door handle
Schäfer ES6050



Nylon
door handle
Schäfer N8051



Aluminium
one hand
door knob
INSAFE



Aluminium
push handle
SLIDESAFE

Hardware Type SV30



Aluminium
door handle
Schäfer AL7050



Stainless steel
door handle
Schäfer ES6050



Nylon
door handle
Schäfer N8051



Aluminium
one hand
door knob
INSAFE



Aluminium
push handle
SLIDESAFE

Hardware Type VK13



Aluminium
one hand door knob
INSAFE



Stainless steel
one hand door knob



Nylon
one hand door knob

Aluminium handrail for the product types EF-3 / SVFG40 / SVF30



Aluminium
handrail
55 x 500 mm
Schäfer ALGS1

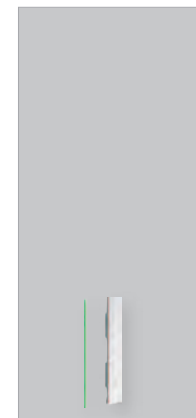

Aluminium
handrail
with LED strip
55 x 500 mm
Schäfer ALGS1 LED



Aluminium
handrail
55 x 1.150 mm
Schäfer ALGS2



Aluminium
handrail
with LED strip
55 x 1.150 mm
Schäfer ALGS2 LED



Aluminium
handrail, adapted
to the door length,
always until the top
edge of the door
Schäfer ALGSV



Aluminium
handrail
with LED strip,
adapted to the door
length, always until
the top edge of
the door
Schäfer ALGSV LED

[To the handrail configuration online tool >](#)

[To the push handle SLIDESAFE >](#)

We reserve the right to make technical alterations.



reddot winner 2021



GERMAN
INNOVATION
AWARD '22
WINNER

